

## 剪板机 Shearing Machines

HGSK HGS

**Yawei** 亚威

股票代码 002559

Stock Code 002559

### 产品目录 Product Catalogue

持续改进 一流品质 02  
Continuous Improvement First-class Quality

HGSK系列 04  
HGSK Series

HGS系列 14  
HGS Series

HGSK系列数控闸式剪板机和HGS系列闸式剪板机是亚威集多年的剪板机设计和制造经验，自主开发的新一代两大系列剪板机，在剪切性能与可靠性方面有质的提升，定会让您感到物有所值。

HGSK series CNC guillotine shear and HGS series guillotine shear are new generation of two series of shearing machines self-developed by Yawei based on the design and manufacturing experience for many years, with quality improvement in the shear performance and reliability, make sure you get the best value in your investment.



### HGSK 系列 数控闸式剪板机 HGSK Series CNC Guillotine Shear

#### 通用型剪板机 Universal Shearing Machine

- 剪切角度、剪切间隙可自动调整，操作简单，剪切精度高，剪切效率高
- Cutting angle and cutting clearance can be adjusted automatically, easy operation, high precision and efficiency for cutting

### 优势 Advancement

- 实现精密剪切的高刚性技术
- 性能卓越的低油温技术
- 完备的刀片应用技术
- 严格的安全防护设置
- 先进的加工工艺和设备
- High rigidity technology to realize high precision shearing
- Low temperature technology with remarkable performance
- Complete blade application technology
- Strict safety guard device
- Advanced processing technology and equipment



### HGS 系列 闸式剪板机 HGS Series Guillotine Shear

#### 精简型剪板机 Conventional Shear

- 剪板间隙可手动调整，操作简单，剪切效率高
- 性价比高，亚威的工艺和质量保障，经久耐用
- Cutting gap can be adjusted manually, easy operation and high efficiency of cutting
- High cost performance, good quality and durable

# HGSK系列 数控闸式剪板机

## HGSK Series CNC Guillotine Shear

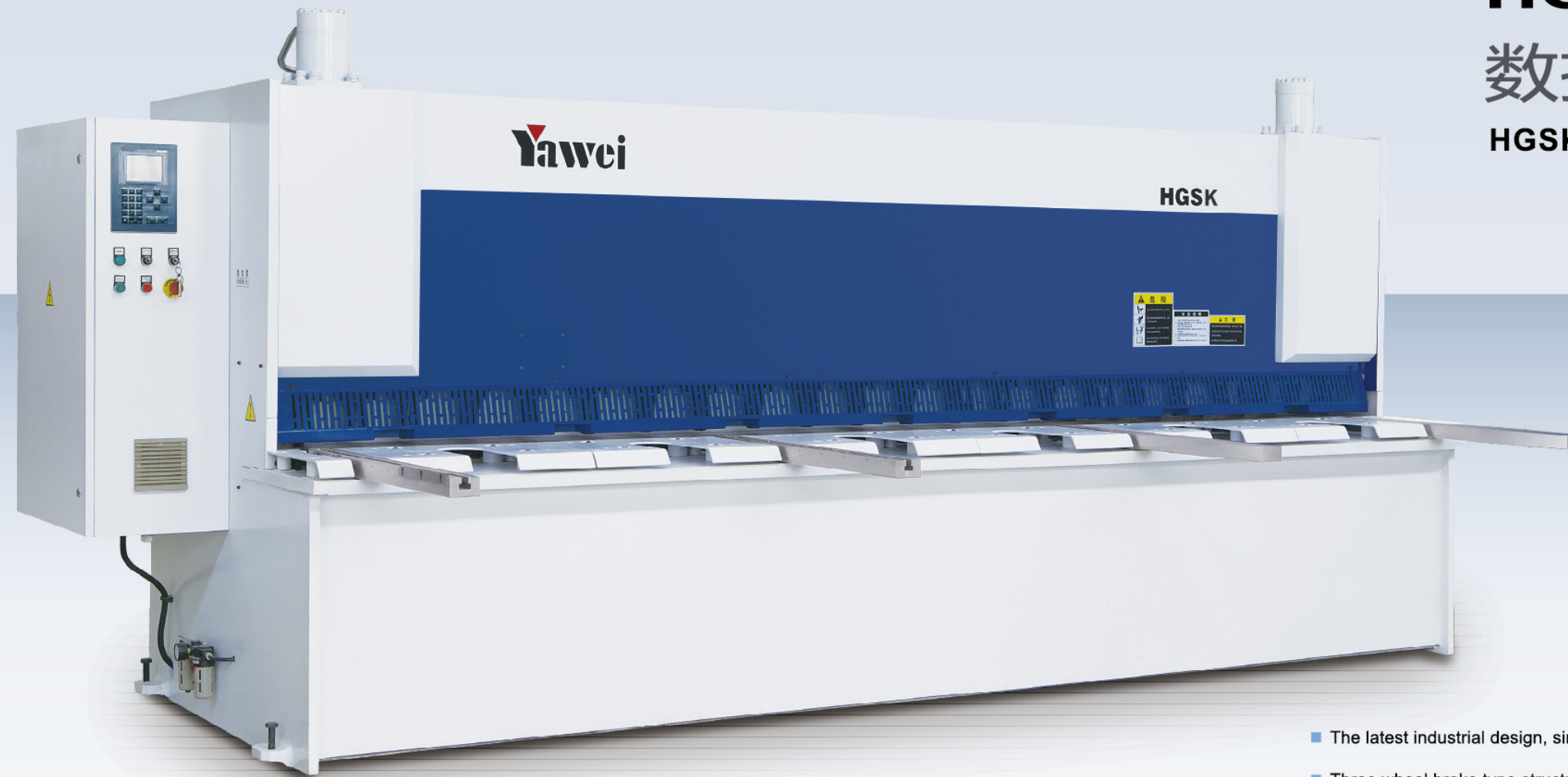

- 最新的工业设计，外形简约大方
- 三点滚轮闸式结构，液压传动，动作平稳
- 可调节刀片间隙和剪切角，提高剪切质量
- 德国进口的液压配置，减少液压系统故障
- 专用的操作系统，操作简单
- 可选配部件多，可提高精度、效率与安全
- 标配高性能优质合金刀片，剪切质量高，刀片使用寿命长
- 采用精密滚珠丝杆和光杆传动的后档料，具有高的速度和大的工作行程，拓宽机器的工作范围，提高生产效率

- The latest industrial design, simple and generous appearance
- Three wheel brake type structure, hydraulic drive and smooth action
- Adjustable blade clearance and cutting angle, improve the quality of cutting
- Imported hydraulic devices from Germany, reduce the hydraulic system breakdown
- Specified operation system, easy operation
- Many optional spare parts, improve the accuracy, efficiency and security
- With high quality alloy blade as standard configuration, high quality for cutting and long life for blade
- Big stroke of backgauge to expand the processing range by fast and precise ballscrew rod transmission

# HGSK系列 闸式剪板机

HGSK Series Guillotine Shear

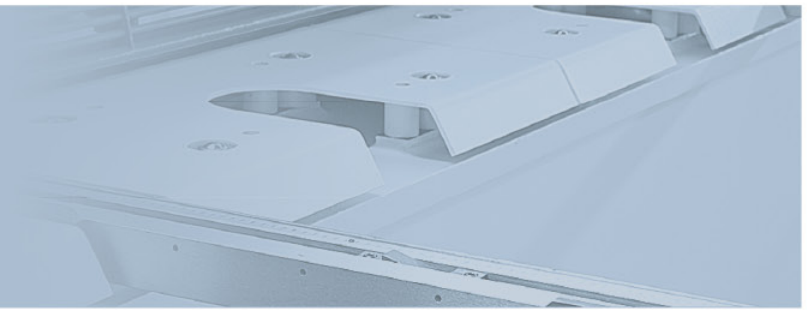

## 结构特点 Structure Feature

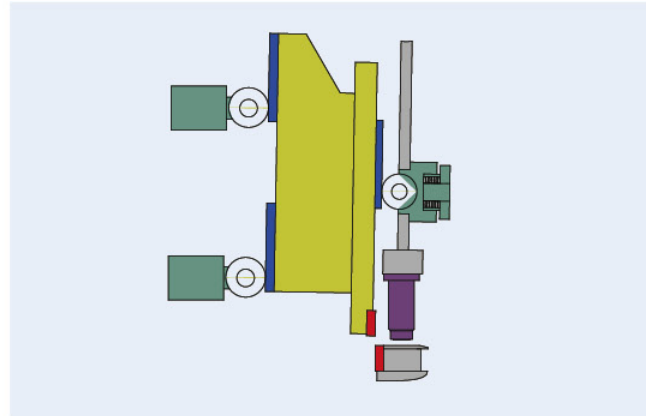

### 导轨结构 Guide Structure

- 采用三点滚轮支撑的刀架导轨结构，前滚轮在预压碟簧的作用下，使刀架始终贴紧在两后侧滚轮上，保证刀架在滚轮间无间隙上下运动，动作平稳
- Adopt three wheel brake type structure, under the force of disc spring, front roller makes the upper beam touch with the two rear rollers all the time, insure the upper beam moves up and down stably without clearance

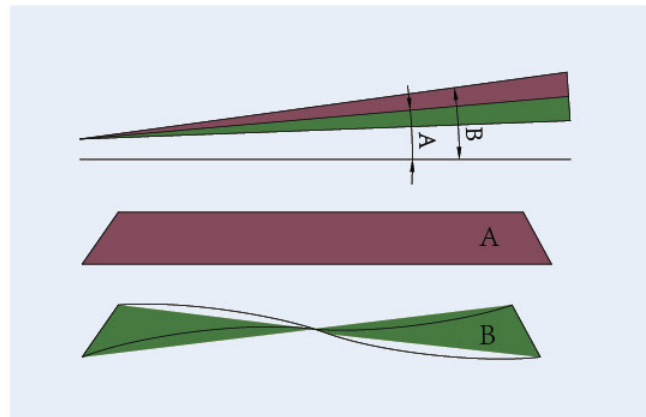

### 可调节剪切角 Adjustable Cutting Angle

- 增大剪切角，剪切工件所需要的力小，工件易产生变形；减小剪切角，剪切工件所需要的力大，工件较平直且断面较光滑
- Increase the cutting angle to low down the cutting force, but the workpiece will deform, decrease the cutting angle to rise the cutting force, the cutting kerf will be straight and smooth

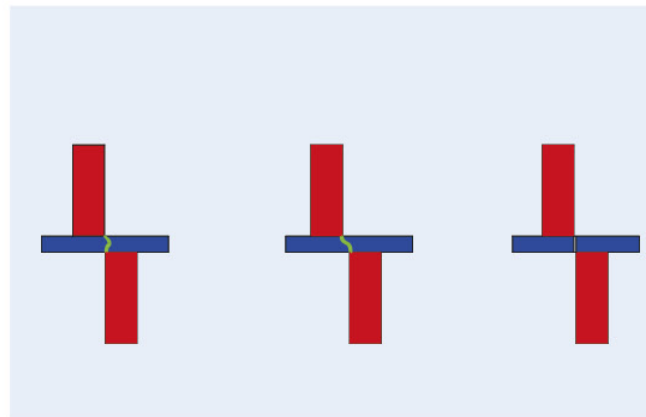

### 可调节刀片间隙 Adjustable Cutting Clearance

- 刀片间隙调节得是否恰当，将直接影响板料的剪切质量和刀片的使用寿命。要想获得高质量的剪切端面，必须根据被剪材质选择合理的刀片间隙
- Appropriate adjustment for blade gap will affect the quality of sheet and life of blade; Reasonable blade clearance should be choosed according to workpiece material to obtine high quality cutting kerf

## 标准配置 Standard Configuration



### 球面工作台 Worktable With Ball

- 装有钢球工作台面，减小送料摩擦阻力和板面的划伤
- Worktable with ball to decrease the friction and the scratch of sheet plate when feeding

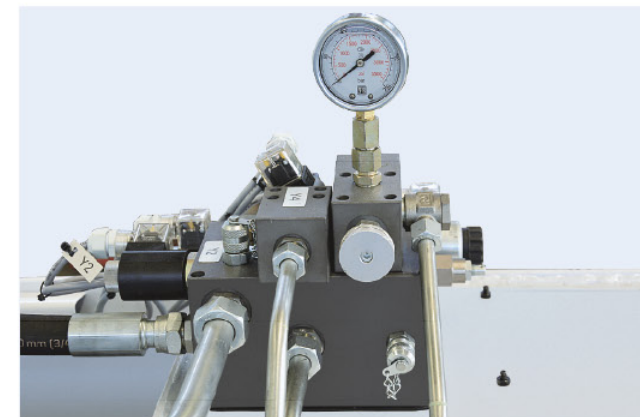

### 液压系统 Hydraulic System

- 采用Rexroth集成式液压系统，蓄能器回程，温升小，确保机器性能稳定可靠
- Adopt integrated hydraulic system from Roxroth, return by accumulator, low tempreture, insure stable and reliable performance



### 数控系统 CNC Controller

- HGSK数控机床：荷兰Delem DAC 360
- HGSK CNC machine: Delem DAC360 from Netherland

# HGSK系列 闸式剪板机

HGSK Series Guillotine Shear

## 可选配置部件 Optional Parts

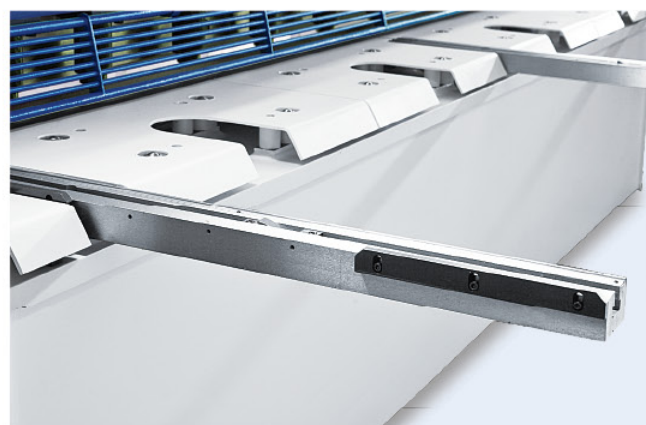

### 特殊长度前支撑臂 Special Length of Front Beam

- 较标准支撑臂更长的支撑臂，长度可根据用户要求定制，方便剪切较大的板料
- Longer front beam than standard length, can be customized, convenient to cut bigger sheet plate



### 角度侧定位装置 Angle Protractor Positioning Device

- 安装在最左侧托料臂上，方便剪切有角度的板料
- 可沿托臂槽前后方向的任意位置固定，保证精确的剪切角度
- Assembled in the left side of front beam, convenient to cut sheet plate with angle
- Move along front beam slot front and rear and position at any place, guarantee the precise cutting angle



### 后防护 Backgauge

- 符合国家安全标准的后防护门，可装有不同安全标准的光电开关，保护进入机床后侧危险区域的人不受伤害
- Rear backgauge according to state safety standard, can equip with different standard of photoelectric switch, protect workers who go inside the dangerous rear side of machine

# HGSK系列 闸式剪板机

HGSK Series Guillotine Shear

## 气动托料 Pneumatic Support



定位型气动托料 ( 数控机型8×4050以下标配 )  
Positioning Pneumatic Sheet Support (standard configuration for shear which is smaller than 8×4050)

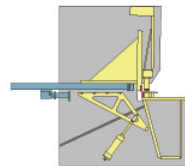

第一步：定位  
First step: positioning

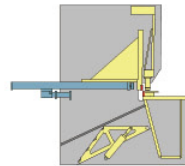

第二步：落料  
Second step: falling sheet



复合型气动托料 ( 8×6100以下选配 )  
Combined Pneumatic Sheet Support (option)

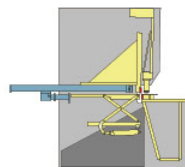

第一步：定位  
Step one: positioning

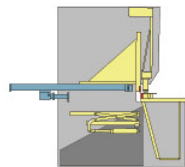

第二步：接料  
Step two: shearing

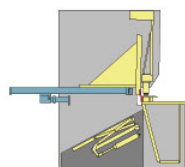

第三步：落料  
Step three: falling sheet

## 后出料装置 ( 选配 ) Rear Discharging Device (option)

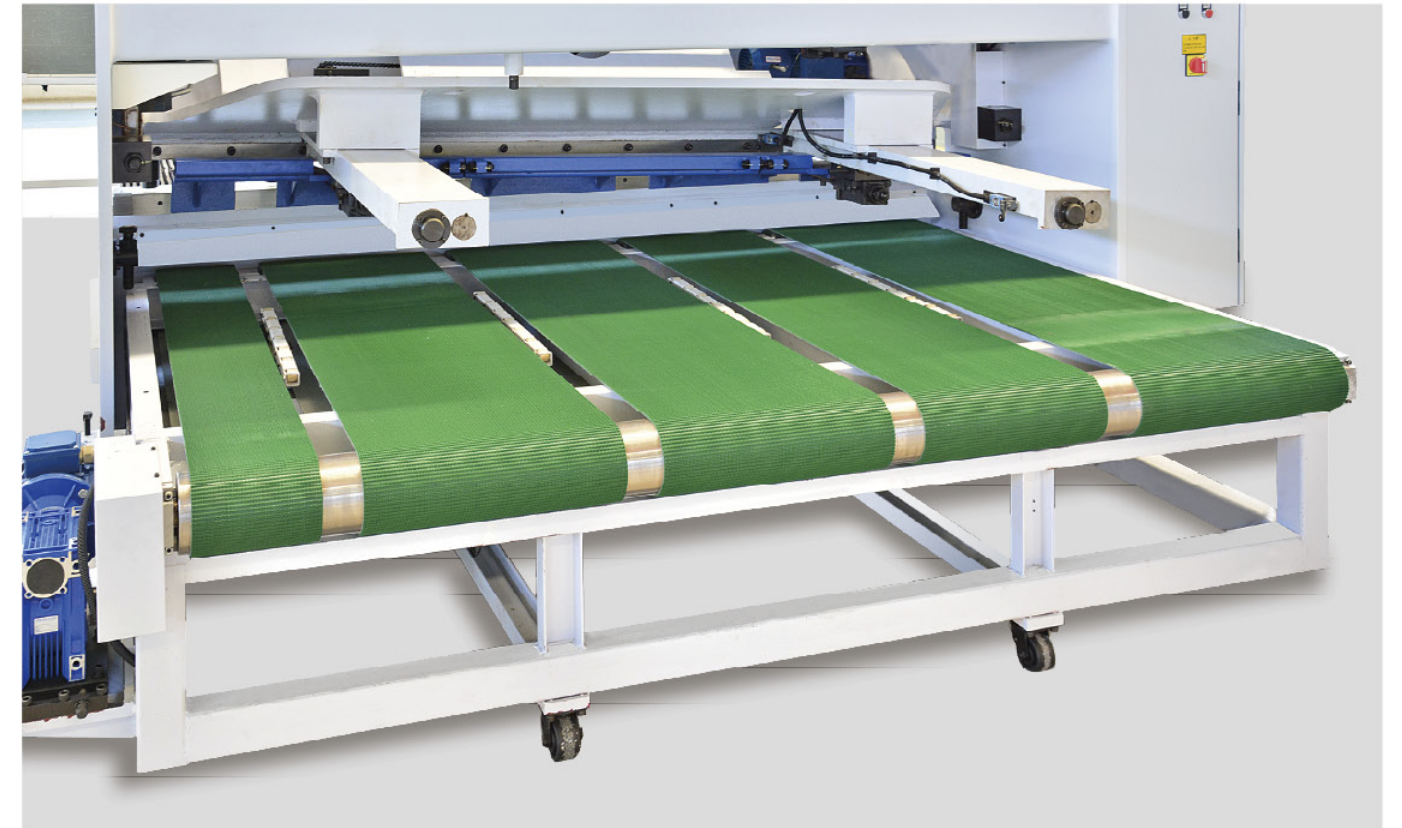

- 板料被输出机器下侧，为操作人员提供安全的工作环境
- 采用聚氨酯输送带，减小板面划伤和噪音
- 配有定位型气动后托料，便于板料定位，保证剪板精度
- 配有脚轮，可轻松移出，便于机器的检修
- 配置机型为小规格机型 ( 8 × 4050以下 )
- Sheet metal is outputting under the machine, provide safe working environment for operators
- Adopt polyurethane conveyor belt, reduce the surface scratch and noise
- Equip with positioning pneumatic sheet support, convenient for plate positioning, ensure cutting accuracy
- Equip with foot wheel, can be easily removed to facilitate the maintenance of the machine
- Especially for small machine (smaller than 8×4050)

# HGSK系列 闸式剪板机

HGSK Series Guillotine Shear

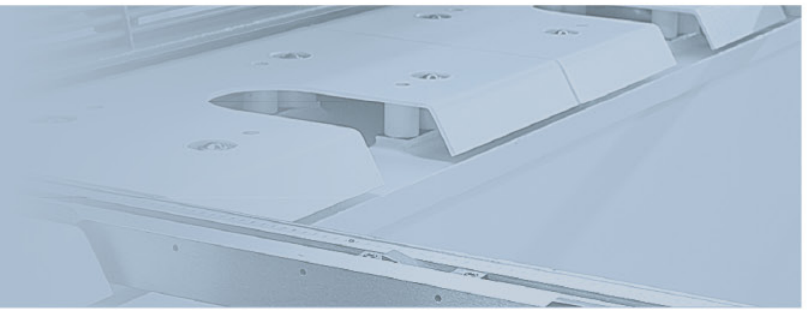

## 前送料装置 (8×4050以下选配) Front Feeding Device (option)

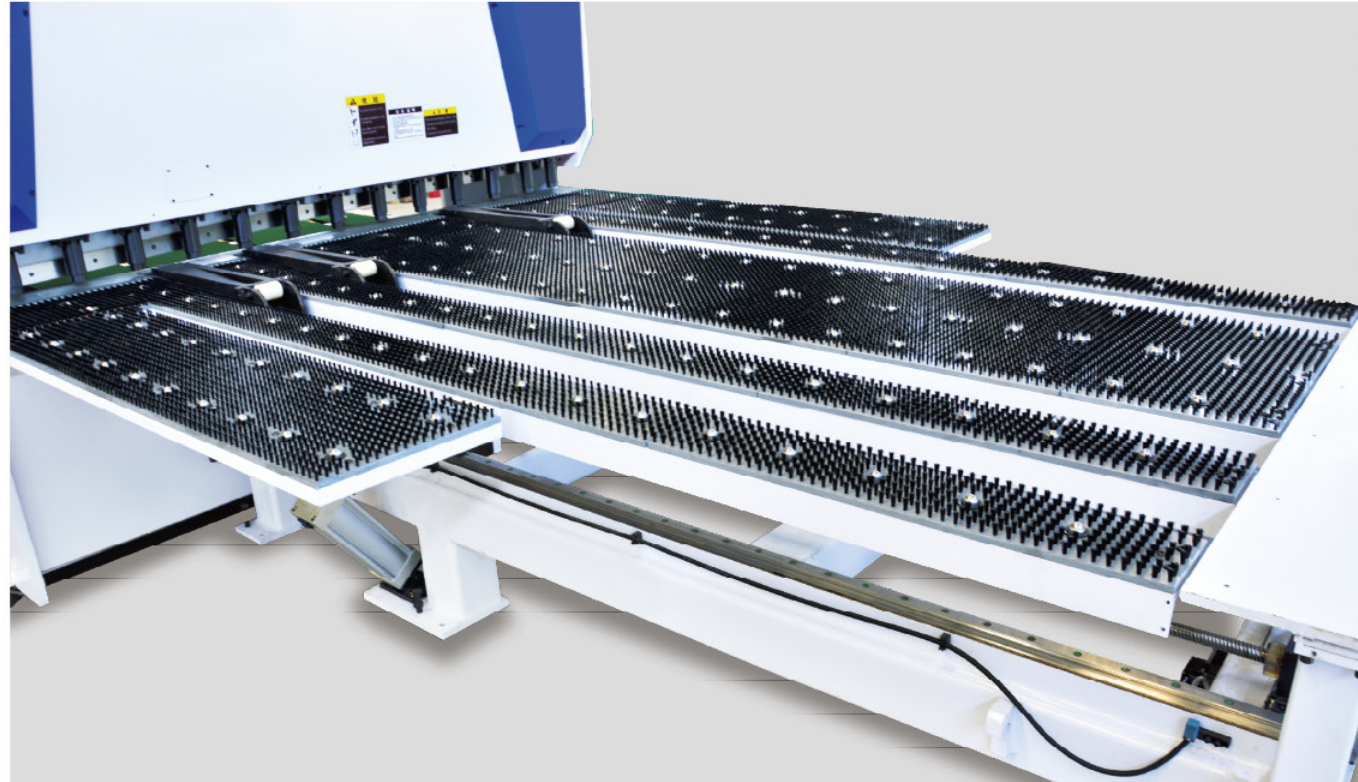

参数名称 Parameter name	单位 Unit	参数值 Parameter values
最大行程 Max stroke	mm	2500
定位精度 Positioning precision	mm	±0.1
最小残料宽度 Min scrap length	mm	100
最小剪切宽度 Min cutting length	mm	440
夹钳数量 Clamp qty	PC	3
电机功率 Motor power	kW	2

- 双滚珠丝杆和直线导轨传动，送料精度更高
- 毛刷嵌钢球工作台面，减小板面划伤
- 气动夹钳，与台面平齐，便于上板料
- 压料油缸前有导向滚轮，便于自动送料，保护压料油缸
- 左右两侧台面可升起或翻落，方便人工剪切
- Driven by double ball screw and linear guide, higher precision for feeding
- Brush worktable with steel balls, reduce the scratch to the material surface
- Pneumatic clamps, parallel with table, convenient for material loading
- Guide wheel in front of the hold-down cylinder, convenient for feeding material automatically, protect the hold-down cylinder
- Left and right side of the table can raise and fall down, convenient for manual cutting

## 技术参数 Technical Parameter

HGSK系列数控闸式剪板机参数 HGSK Series CNC Guillotine Shear Data												
型号 Model	可剪板厚 Max. Cutting thickness	可剪板宽 Max. Cutting length	剪切角 Cutting angle	压脚数量 Clamp qty	全行程次数 (空载) Strokes (no load)	后挡料行程 Backgauge stroke	主电机 功率 Power of main motor	油箱容积 Volume of oil tank	外形 Overall dimension			重量 Weight
									L	W	H	
	mm	mm	°		min <sup>-1</sup>	mm	kW	l	mm			kg
HGSK-6×2500	6	2500	0.5-2	14	18	10-1000	7.5	250	3110	1970	2050	5500
HGSK-6×3050	6	3050	0.5-2	17	16	10-1000	7.5	250	3670	1970	2050	6300
HGSK-6×4050	6	4050	0.5-2	22	14	10-1000	7.5	250	4670	2070	2180	9000
HGSK-6×5000	6	5000	0.5-2	24	12	10-1000	15	650	5720	2400	2500	14500
HGSK-6×6100	6	6100	0.5-2	27	10	10-1000	15	650	6860	2500	2630	20300
HGSK-8×3050	8	3050	0.5-2	17	13	10-1000	11	320	3680	2020	2100	7400
HGSK-8×4050	8	4050	0.5-2	22	11	10-1000	15	320	4680	2080	2200	10800
HGSK-8×5000	8	5000	0.5-2	20	13	10-1000	22	650	5760	2420	2550	18000
HGSK-8×6100	8	6100	0.5-2	24	11	10-1000	22	650	6870	2500	2650	22500
HGSK-8×8100	8	8100	0.5-2	30	10	10-1000	30	1000	8960	2700	2850	44200
HGSK-10×4050	10	4050	0.5-2	18	11	10-1000	22	650	4770	2300	2400	13000
HGSK-13×2500	13	2500	0.5-2.5	12	11	10-1000	22	650	3240	2280	2600	9000
HGSK-13×3050	13	3050	0.5-2.5	14	10	10-1000	22	650	3790	2280	2350	10000
HGSK-13×4050	13	4050	0.5-2.5	18	9	10-1000	30	650	4810	2350	2500	15200
HGSK-13×5000	13	5000	0.5-2.5	22	8	10-1000	30	650	5860	2400	2600	24000
HGSK-13×6100	13	6100	0.5-2.5	26	6	10-1000	30	1000	6960	2500	2900	33000
HGSK-13×7100	13	7100	0.5-2.5	31	5	10-1000	37	1100	7960	2600	3150	45000
HGSK-13×8100	13	8100	0.5-2.5	36	5	10-1000	37	1100	8960	2700	3450	60000
HGSK-16×2500	16	2500	0.5-2.5	12	10	10-1000	22	650	3280	2350	2700	11500
HGSK-16×3050	16	3050	0.5-2.5	14	9	10-1000	22	650	3830	2350	2450	12800
HGSK-16×4050	16	4050	0.5-2.5	18	8	10-1000	30	650	4830	2380	2520	18000
HGSK-16×5000	16	5000	0.5-2.5	26	6	10-1000	37	1000	5880	2500	2900	30500
HGSK-16×6100	16	6100	0.5-2.5	31	5	10-1000	37	1000	6980	2550	3000	39000
HGSK-16×8100	16	8100	0.5-2.5	36	5	10-1000	45	1100	8980	2700	3500	70500
HGSK-20×2500	20	2500	0.5-2.5	13	7	10-1000	30	650	3450	2350	2850	14600
HGSK-20×3050	20	3050	0.5-2.5	16	7	10-1000	30	650	4000	2350	2500	16200
HGSK-20×4050	20	4050	0.5-2.5	20	7	10-1000	37	800	5200	2500	3000	28000
HGSK-20×5000	20	5000	0.5-2.5	24	6	10-1000	55	1100	6000	2700	3350	44000
HGSK-20×6100	20	6100	0.5-2.5	27	5	10-1000	55	1100	7100	2800	3450	55000
HGSK-25×2500	25	2500	0.5-2.5	13	6	10-1000	45	1000	3500	2400	3100	22000
HGSK-25×3050	25	3050	0.5-2.5	16	6	10-1000	45	1000	4150	2450	3200	24000
HGSK-25×4050	25	4050	0.5-2.5	20	4	10-1000	55	1500	5050	2500	3000	38500
HGSK-30×3050	30	3050	0.5-3.5	16	4	10-1000	55	1100	4250	2650	3020	33300

可设计制造特殊参数规格的产品 Shears with special specifications can be designed and manufactured

# HGS系列 闸式剪板机

## HGS Series Guillotine Shear



- 最新的工业设计，外形简约大方
  - 局部结构优化的闸式结构，性能更加稳定
  - 快速调整刀片间隙，适应不同厚度板料剪切
  - 较小剪切角，减小扭曲变形，提高剪切质量
  - 后挡料可微调，操作方便
  - 具有行程调节功能，提高加工效率
  - 灯光对线装置，便于划线剪切
  - 实用高效、稳定可靠、高性价比，低故障率
- The latest industrial design, simple and generous appearance
  - Local structured pendulum structure, more stable
  - Adjustable blade clearance with fast speed and suitable for different thickness of material cutting
  - Smaller cutting angle, reduces the twist and deformation, improves cutting quality
  - Backgauge can be adjusted slightly, easy operation
  - Function of stroke adjustment, improve the processing efficiency
  - Light alignment device, easy for cutting with lineation
  - Practical and efficient, stable and reliable, cost-effective and low failure rate

### 标准配置 Standard Configuration

- 球面工作台
- 后挡料交流电机驱动，T型丝杆传动
- Rexroth集成式液压阀块
- E21S系统精确显示后挡料位置，也可实现简易数控功能
- Worktable with ball steel
- Backgauge driven by AC motor, moved by T-screw
- Rexroth integrated hydraulic valve block
- E21S system exactly display position of backgauge, can realize simple NC function



ESTUN E21S

### 可选择配置 Optional Configuration

- 定位型气动后托料
- 加长前托料臂
- 角度测定装置
- 简易后防护
- Positioning pneumatic backgauge
- Longer front beam
- Angle protractor device
- Simple backgauge safety guard

### 技术参数 Technical Parameter

HGS系列闸式剪板机参数 HGS Series Guillotine Shear Data												
型号 Model	可剪板厚 Max. Cutting thickness mm	可剪板宽 Max. Cutting length mm	剪切角 Cutting angle °	压脚数量 Clamp qty	全行程次数 (空载) Strokes (no load) min <sup>-1</sup>	后挡料行程 Backgauge stroke mm	主电机 功率 Power of main motor kW	油箱容积 Volume of oil tank l	外形 Overall dimension mm			重量 Weight kg
									L	W	H	
HGS-6x2500	6	2500	0.5-2	14	18	10-1000	7.5	250	3110	1970	2050	5500
HGS-6x3050	6	3050	0.5-2	17	16	10-1000	7.5	250	3670	1970	2050	6300
HGS-6x4050	6	4050	0.5-2	22	14	10-1000	7.5	250	4670	2070	2180	9000
HGS-6x5000	6	5000	0.5-2	24	12	10-1000	15	650	5720	2400	2500	14500
HGS-6x6100	6	6100	0.5-2	27	10	10-1000	15	650	6860	2500	2630	20300
HGS-8x3050	8	3050	0.5-2	17	13	10-1000	11	320	3680	2020	2100	7400
HGS-8x4050	8	4050	0.5-2	22	11	10-1000	15	320	4680	2080	2200	10800
HGS-8x5000	8	5000	0.5-2	20	13	10-1000	22	650	5760	2420	2550	18000
HGS-8x6100	8	6100	0.5-2	24	11	10-1000	22	650	6870	2500	2650	22500
HGS-8x8100	8	8100	0.5-2	30	10	10-1000	30	1000	8960	2700	2850	44200
HGS-10x4050	10	4050	0.5-2	18	11	10-1000	22	650	4770	2300	2400	13000
HGS-13x2500	13	2500	0.5-2.5	12	11	10-1000	22	650	3240	2280	2600	9000
HGS-13x3050	13	3050	0.5-2.5	14	10	10-1000	22	650	3790	2280	2350	10000
HGS-13x4050	13	4050	0.5-2.5	18	9	10-1000	30	650	4810	2350	2500	15200
HGS-13x5000	13	5000	0.5-2.5	22	8	10-1000	30	650	5860	2400	2600	24000
HGS-13x6100	13	6100	0.5-2.5	26	6	10-1000	30	1000	6960	2500	2900	33000
HGS-13x7100	13	7100	0.5-2.5	31	5	10-1000	37	1100	7960	2600	3150	45000
HGS-13x8100	13	8100	0.5-2.5	36	5	10-1000	37	1100	8960	2700	3450	60000
HGS-16x2500	16	2500	0.5-2.5	12	10	10-1000	22	650	3280	2350	2700	11500
HGS-16x3050	16	3050	0.5-2.5	14	9	10-1000	22	650	3830	2350	2450	12800
HGS-16x4050	16	4050	0.5-2.5	18	8	10-1000	30	650	4830	2380	2520	18000
HGS-16x5000	16	5000	0.5-2.5	26	6	10-1000	37	1000	5880	2500	2900	30500
HGS-16x6100	16	6100	0.5-2.5	31	5	10-1000	37	1000	6980	2550	3000	39000
HGS-16x8100	16	8100	0.5-2.5	36	5	10-1000	45	1100	8980	2700	3500	70500
HGS-20x2500	20	2500	0.5-2.5	13	7	10-1000	30	650	3450	2350	2850	14600
HGS-20x3050	20	3050	0.5-2.5	16	7	10-1000	30	650	4000	2350	2500	16200
HGS-20x4050	20	4050	0.5-2.5	20	7	10-1000	37	800	5200	2500	3000	28000
HGS-20x5000	20	5000	0.5-2.5	24	6	10-1000	55	1100	6000	2700	3350	44000
HGS-20x6100	20	6100	0.5-2.5	27	5	10-1000	55	1100	7100	2800	3450	55000
HGS-25x2500	25	2500	0.5-2.5	13	6	10-1000	45	1000	3500	2400	3100	22000
HGS-25x3050	25	3050	0.5-2.5	16	6	10-1000	45	1000	4150	2450	3200	24000
HGS-25x4050	25	4050	0.5-2.5	20	4	10-1000	55	1500	5050	2500	3000	38500
HGS-30x3050	30	3050	0.5-3.5	16	4	10-1000	55	1100	4250	2650	3020	33300

可设计制造特殊参数规格的产品 Shears with special specifications can be designed and manufactured



**江苏亚威机床股份有限公司**  
JIANGSU YAWEI MACHINE TOOL CO., LTD.

**中国**

江苏扬州市江都区黄海南路仙城工业园

邮编: 225200

销售电话: 0514-86880518 86880528 86519118

售后服务: 0514-86880538 86519128 86519158

配件销售: 0514-86519148

传真: 0514-86882218 86519188

网址: [www.yawei.cc](http://www.yawei.cc)

电邮: [sales1@yawei.cc](mailto:sales1@yawei.cc)

**INTERNATIONAL**

XIANCHENG INDUSTRIAL ZONE, HUANGHAI SOUTH ROAD

JIANGDU DIST. 225200 YANGZHOU, JIANGSU, CHINA

Sales hot line: +86-514-86880517 +86-514-86880518

Service phone: +86-514-86880517 +86-514-86880538

Part sales phone: +86-514-86519148

FAX: +86-514-86880521 +86-514-86882218

HTTP: [www.yawei.cc](http://www.yawei.cc)

Email: [sales2@yawei.cc](mailto:sales2@yawei.cc)



以上两个标志皆为江苏亚威机床股份有限公司的商标  
The above two marks both are commercial brand of Jiangsu Yawei Machine Tool Co., Ltd.

产品不断改进, 样本如有变动恕不另行通知  
The contents are subject to change without prior notice



亚威公众微信  
YAWEI WeChat